

FURITEK

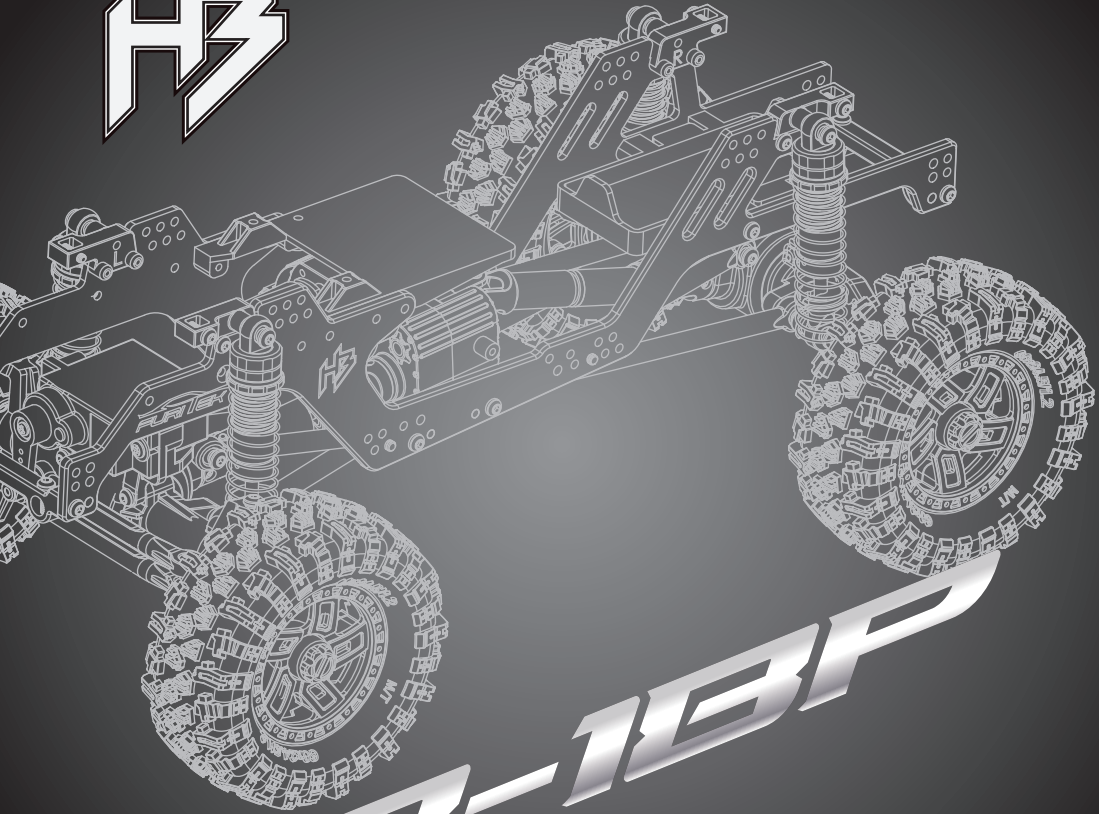

CR-16P
2024

Next Level of Micro Crawler performance

Precautions!

Read the safety messages listed below before operation!

- Do not use the product at night or during bad weather conditions, like rain or thunderstorms. It can cause erratic operation or loss of control.
- Do not use the product when visibility is limited.
- Do not expose the product to rain or snow. Any exposure to moisture (water or snow) may cause erratic operation or loss of control.
- Interference may cause loss of control. To ensure the safety of you and others, do not operate in the following places:

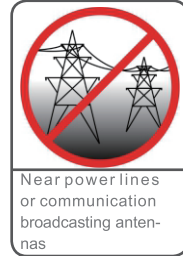

- Do not use this product when you are tired, uncomfortable, or under the influence of alcohol or drugs. Doing so may cause serious injury to yourself or others.
- The 2.4GHz radio band is limited to line of sight. Always keep your model in sight as a large can block the RF signal and lead to loss of control.
- Never grip the transmitter antenna during operation. It significantly degrades signal quality and strength and may cause loss of control.
- Do not touch any part of the model that may generate heat during operation, or immediately after use. The engine, motor or speed control, may be very hot and can cause serious burns.
- Misuse of this product may lead to serious injury or death. To ensure the safety of you and your equipment, read this manual and follow the instructions carefully.
- Make sure the product is properly installed in your model. Failure to do so may result in serious injury.
- Make sure that the receiver's battery is disconnected before turning off the transmitter. Failure to do so may lead to unintended operation and cause an accident.
- Ensure that all motors operate in the correct direction. If not, adjust the direction first.
- Make sure that the model stays within range in order to prevent loss of control.
- The antenna(s) used for this transmitter must be installed to provide a separation distance of at least 20 cm from all persons and must not be co-located or operating in conjunction with any other transmitter. End-users and installers must be provided with antenna installation instructions and transmitter operating conditions for satisfying RF exposure compliance.
- Hereby, [Flysky Technology co., ltd] declares that the Radio Equipment [FS-MG41] is in compliance with RED 2014/53/EU.
- The full text of the EU DoC and Appendix 1 of the FCC Statement are available at the following internet address: www.flysky-cn.com
- CAUTION
- RISK OF EXPLOSION IF BATTERY IS REPLACED BY AN INCORRECT TYPE. DISPOSE OF USED BATTERIES ACCORDING TO THE INSTRUCTIONS.

Transmitter Overview

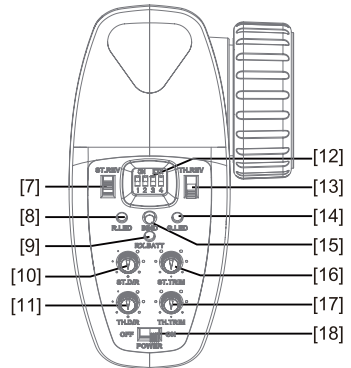
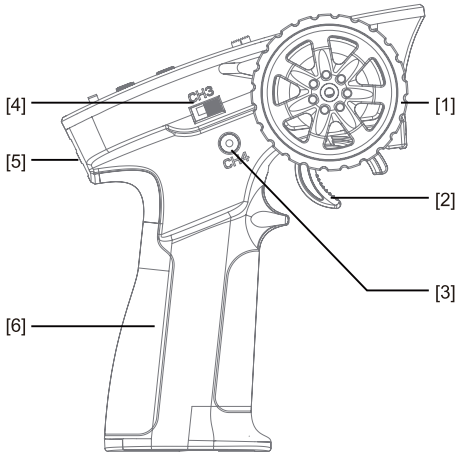

[1]	Wheel Angle, the maximum rotation of the steering wheel is 35 degrees from center to left or right (CH1)	[10]	Steering D/R (ST.D/R)
[2]	Throttle trigger, has a total throw of 12 degrees, 12.5 degrees forward, and 12.5 degrees backward (CH2)	[11]	Throttle D/R (TH.D/R)
[3]	Button (CH4)	[12]	Dial Switch (Switching the working mode of the electric dispatching)
[4]	Three-position switch (CH3)	[13]	Throttle Reverse Switch (TH.REV)
[5]	Lanyard Eye	[14]	Status indicator green LED (G.LED)
[6]	Handle, 4 * AAA battery compartment	[15]	Bind Button (BIND)
[7]	Steering Reverse Switch (ST.REV)	[16]	Steering Trim (ST.TRIM)
[8]	Power indicator LED (R. LED)	[17]	Throttle Trim (TH.TRIM)
[9]	Two color LED battery volume (RX.BATT)	[18]	Power Switch

Basic Operations

► Install the Battery

Battery Type: AAA

Battery Installation:

1. Open the battery compartment cover.
2. Insert 4 fully-charged AAA batteries into the compartment. Make sure that the battery makes good contact with the battery compartment's contacts.
3. Replace battery compartment cover.

Low battery alarm: When the battery is lower than 4.2V, the G.LED on the panel will flash slowly.

Note: When installing the battery, please pay attention to the positive and negative poles of the battery to avoid installation errors. (As shown on the right)

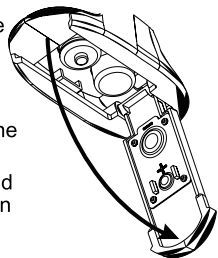

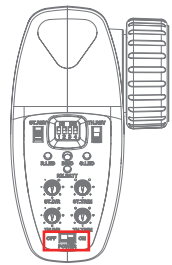

► Power on

Follow the steps below to turn on the transmitter:

1. Check to make sure that that battery is fully charged and installed correctly.
2. Toggle the switch to the [ON] position. When active the R.LED will be lit.
3. Connect the receiver to power.

For safety always power on the transmitter before the receiver.

► Binding

The transmitter and receiver have been pre-bound before delivery. If you are using another receiver, follow the steps below to bind the transmitter and receiver :

1. Turn on the transmitter while holding the bind button to enter bind mode. G.LED will start flashing quickly.
 - Once in bind mode release the bind button.
2. The receiver will enter bind mode automatically when powered on.
3. Once binding is successful the receivers and transmitter's LED will remain solid .

Note: When binding, put the transmitter into bind mode first, then the receiver. If the Binding does not finish in 10s, The receiver will quit bind mode automatically.

⚠ This binding information only applies to the FS-MG41 and the HW-709/HW-711/FS-R4A receiver, different receivers may require a different procedure to complete the binding process. Please visit the official FLYSKY website for the latest information on compatible receivers and their respective usermanuals.

⚠ Product information is updated regularly, please visit our website for more information.

► Stick Calibration

This function is used to set the neutral position for throttle and wheel.

Every transmitter is calibrated before leaving the factory, however if recalibration is required, please follow these steps:

1. Turn and hold the wheel as far clockwise as it will turn, hold the throttle all the way forward, then turn on the transmitter in calibration mode.
 - The R.LED and G.LED will flash twice.
2. Calibrate wheel: Turn the wheel completely clockwise, then completely counterclockwise.
 - When calibration is completed the R.LED will be off.
3. Trigger calibration: Pull the trigger back then forward as far as it will go.
 - When calibration is completed the G.LED will be off.
4. Once calibration is complete press the bind key to save and exit.

► Failsafe

This function dictates what the receiver will do in the event that it loses signal from the transmitter, this includes servo position etc.

Setup:

- Turn on the transmitter and make sure it is connected to the receiver. Hold the control surface at the desired failsafe position. Press and hold the bind button for 3 seconds, if the G.LED starts flashing every 2 seconds then setup has been successful. Failsafe is now set and will default to these values when the receiver loses signal.

Note: The fail-safe function has no default set at the factory and as such must be set manually. If no failsafe setting has been set, then the receiver will not output anything when signal is lost.

► Power Off

Follow the steps below to turn off the system:

1. Disconnect the receiver power.
2. Toggle the transmitter's power switch to the off position.

⚠ Make sure to disconnect the receiver power before turning off the transmitter. Failure to do so may lead to damage or serious injury.

Specifications

Product Name	FS-MG41
Channels	4
Model Type	Car, Boat
RF	2.4 GHz
RF power	Less than 20 dBm
2.4GHz system	ANT
Distance	>150m(ground distance without interference)
Channel Resolution	1024
Low Voltage alarm	Less than 4.2 V
Power Input	6V DC 1.5AAA*4
Temperature Range	-10°C—+60°C
Humidity Range	20—95%
Dimension	118mm x 73mm x 145mm
Weight	130g
Certificate	CE , FCC ID : N4ZMG400

Specifications

- Product Name: FS-R4A3-BS
- Adaptive Transmitters: FS-MG43-BS
- Adaptive Models : 1:18 simulation cars, climbing cars
- Number of Channels: 4
- Number of Lights: 7
- RF: 2.4GHz ISM
- 2.4G Protocol: 2A-BS
- Antenna: Single antenna
- Input Power: NiMH (5~7Cell)/ 2S Lithium batteries
- Continuous/Peak Current: 10A/50A
- Data Output: PWM
- Temperature Range: -10°C ~ +60°C
- Humidity Limit: 20%~95%
- Waterproof: PPX4
- Distance: >150m(Ground distance without inference)
- Online Update: NO
- Dimensions: 33mm*30mm*12mm (Excluding capacitor)
- Weight: 11g
- BEC Output: 6V/1A
- Certification: CE, FCC ID: N4ZR4A31

Charging the Battery

1. Connect the charger to a USB port then connect the battery to the charger.
2. When charging, the status LED is red, when charged, the status LED is green.
3. Do not let the battery charge unattended!
4. If the battery or charger is hot, disconnect the battery and charger immediately as this may be caused by an internal short-circuit.

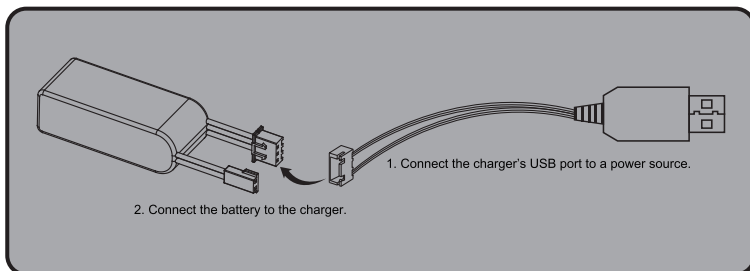

Certification

FCC Compliance Statement

This device complies with Part 15 of the FCC Rules. Operation is subject to the following two conditions: (1) this device may not cause harmful interference, and (2) this device must accept any interference received, including interference that may cause undesired operation.

Warning: changes or modifications not expressly approved by the party responsible for compliance could void the user's authority to operate the equipment.

This equipment has been tested and found to comply with the limits for a Class B digital device, pursuant to Part 15 of the FCC Rules. These limits are designed to provide reasonable protection against harmful interference in a residential installation. This equipment generates, uses and can radiate radio frequency energy and, if not installed and used in accordance with the instructions, may cause harmful interference to radio communications. However, there is no guarantee that interference will not occur in a particular installation. If this equipment does cause harmful interference to radio or television reception, which can be determined by turning the equipment off and on,

the user is encouraged to try to correct the interference by one or more of the following measures:

Reorient or relocate the receiving antenna.

Increase the separation between the equipment and receiver.

Connect the equipment into an outlet on a circuit different from that to which the receiver is connected.

Consult the dealer or an experienced radio/TV technician for help.

EU DoC Declaration

Hereby, [Flysky Technology co., Ltd] declares that the Radio Equipment [FS-R4A3-BS] is in compliance with RED 2014/53/EU.

The full text of the EU DoC is available at the following internet address: www.flysky-cn.com.

RF Exposure Compliance

This equipment complies with FCC radiation exposure limits set forth for an uncontrolled environment. This equipment should be installed and operated with minimum distance 20cm between the radiator and your body. This transmitter must not be co-located or operating in conjunction with any other antenna or transmitter.

Environmentally friendly disposal

Old electrical appliances must not be disposed of together with the residual waste, but have to be disposed of separately. The disposal at the communal collecting point via private persons is for free. The owner of old appliances is responsible to bring the appliances to these collecting points or to similar collection points. With this little personal effort, you contribute to recycle valuable raw materials and the treatment of toxic substances.

IC STATEMENT

This device contains licence-exempt transmitter(s)/receiver(s) that comply with Innovation, Science and Economic Development Canada's licence-exempt RSS (s). Operation is subject to the following two conditions:

(1) This device may not cause interference.

(2) This device must accept any interference, including interference that may cause undesired operation of the device.

L'émetteur/récepteur exempt de licence contenu dans le présent appareil est conforme aux CNR d'Innovation, Sciences et Développement économique Canada applicables aux appareils radio exempts de licence. L'exploitation est autorisée aux deux conditions suivantes :

1. L'appareil ne doit pas produire de brouillage;

2. L'appareil doit accepter tout brouillage radioélectrique subi, même si le brouillage est susceptible d'en compromettre le fonctionnement.



FCC ID: N4ZR4A31

IC: 25584-R4A31

Lithium Polymer (LiPo) Battery Warning

- Never charge a lithium polymer battery with a charger designed for Nicd, NIMH, or any other type of battery chemistry. Use ONLY charger designed for LiPo battery.
- Do not leave LiPo battery unattended during charging.
- Do not overcharge the battery.
- Always charge LiPo batteries on non-flammable, heat-resistant surfaces.
- Always use a LiPo-safe bag or container while charging. Do not allow LiPo cells to overheat at any time. Cells which reach greater than 140 Fahrenheit(60°C) will usually become damaged and will catch fire.
- Do not charge the LiPo pack while it is still in the model. Never charge or store battery packs in a vehicle.
- Do not discharge LiPo; doing so will damage the battery.
- Do not expose LiPo cell to water or moisture at any time.
- Do not store battery near open flame or heater.
- Do not assemble LiPo cells or pre-assembled packs together with other LiPo cells or packs.
- Always store LiPo battery in a secure location away from children.
- Always remove the LiPo battery if model is involved in any kind of crash.
- Carefully inspect the battery and connectors for even the smallest damage.
- CAUTION: Cells may become hot after usage. Allow the pack to cool to room temperature prior to recharging.
- Do not allow the electrolyte to get into eyes or on skin. Wash affected areas immediately if they come into contact with electrolyte. Do not alter or modify connectors or wires of a LiPo battery pack.
- Always inspect the condition of the battery before charging and operating.
- Do not short circuit the LiPo battery.
- Do not have contact with a leaky/damaged battery directly.
- Do not charge battery out of recommended temperature range(0°C-45°C).

Introduction

FS-R4P is a receiver in compliance with the ANT protocol, providing 4-channel and one-way transmission. It is equipped with built-in antenna, featuring PPX4 waterproof and the compact design. The receiver will enter the binding state once it is powered on, outputting PWM signal. It can be adapted to a variety of car models.

Receiver overview

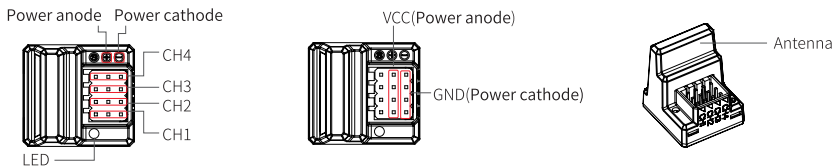

Product specification

- Product Name: FS-R4P
- Compatible Transmitters: Transmitter with ANT protocol, such as FS-G4P, FS-G7P (Refer to TX-RX FORM on the official website for details.)
- Model Type: Cars
- PWM Channels: 4
- RF: 2.4GHz ISM
- 2.4G Protocol: ANT
- Antenna: Single built-in antenna
- Distance: > 150m (Ground distance without interference)
- Input Power: 3.5 ~ 8.4V/DC
- Working Current: 70mA(5V)
- Data Output: PWM
- Temperature Range: -10°C ~ +60°C
- Humidity Range: 20% ~ 95%
- Waterproof: PPX4
- Online Update: No
- Dimensions: 22.6*20.6*25.5mm
- Weight: 6g
- Certification: CE, FCC, UKCA

Installation

The receiver has a built-in antenna. In order to ensure the signal quality and avoid the remote control distance affected, the receiver antenna should be perpendicular to the model body (as shown in the figure) when installing the receiver, and the receiver antenna should be vertical!

Binding

The receiver automatically enters the binding state once it is powered on.

1. First put the transmitter into bind mode (See the transmitter's user manual for instructions on how to activate bind mode.)
2. When the receiver is powered on and waits for 1 second, it will automatically enter the binding state if it is not connected.
3. After the receiver LED becomes slow flashing, then restart the transmitter or put the transmitter to exit the binding state. At this time, the receiver LED is solid on indicating the binding is successful.
4. Verify that the transmitter and receiver are working properly. If you need to re-bind, repeat the above steps.

Note:

1. Set the transmitter to its binding state first, and then set the receiver to its binding state. If the binding is not finished within 10s, the LED of the receiver will enter its slow flashing state.;
2. Because this receiver only supports one-way binding, if the binding transmitter supports one-way and two-way mode binding, please set the one-way mode at the transmitter side before starting the binding.

Failsafe

This function protects the user by preventing the model from behaving unexpectedly if signal is lost. The receiver defaults to have no signal output after it is out of control. If you set failsafe value at the transmitter side, the set value will be output if the signal is lost.

⚠ Attention:

- Make sure the product is installed and calibrated correctly, failure to do so may result in serious injury.
- Make sure the receiver's battery is disconnected before turning off the transmitter, failure to do so can result out of control. Unreasonable setting of the Failsafe may cause accidents.
- Make sure the receiver is mounted away from motors, electronic speed controllers or any device that emits excessive electrical noise.
- Keep the receiver's antenna at least 1cm away from conductive materials such as carbon or metal.
- Do not power on the receiver during the setup process to prevent loss of control.

Car light control

The car light control is mainly to implement the changeover of lighting states and lighting modes by the setting of the transmitter.

This receiver is preset with five modes for controlling model car lights. In each mode, the on/off states of backup lights are consistent; in other words, the backup light is in a high-light state when the model car backs up; otherwise, it is in off state. The turn signal light, headlight, stop light, tail light and fog light have different on/off states as follows:

- Default mode : In this mode, the turn signal light is in off state regardless of whether the model car makes a turn or not; When braking, the stop light is in a high-light state, and otherwise, it is in off state; The headlight, tail light and fog light are in off state.
- Mode A : In this mode, the turn signal light is in a slow flashing state when the model car makes a turn; When braking, the stop light is in a high-light state, and when not braking, it is in a low-light state; The headlight is in a low-light state; The tail light and fog light are in off state.
- Mode B : In this mode, the turn signal light is in a slow flashing state when the model car makes a turn; When braking, the stop light is in a high-light state, and when not braking, it is in a low-light state; The headlight is in a high-light state; The tail light and fog light are in off state.
- Mode C: In this mode, the turn signal light is in slow flashing when the model car makes turn. When braking , the stop light is in high-light state and when not braking it is in low-light state. The head light is in a high-light state and the fog light in on state.
- Mode D: In this mode, the turn signal light is in a continuously slow flashing state regardless of whether the model car makes a turn or not; When braking, the stop light is in a high-light state, and when not braking, it is in a low-light state; The headlight is in a high-light state; The tail light and fog light are in on state.

Notes:

- 1.The CH4 channel of the receiver can output both the light mode signal and the PWM signal. It needs to be set at the transmitter side. Press the CH4 button on the transmitter for a short time, the CH4 channel outputs the light mode. Each time it is pressed,one mode per press (Default Mode, Mode A, Mode B, Mode C and Mode D are switched in turn); Press and hold the CH4 button for a while,then switch the CH4 channel to PWM output.
- 2.Every time the receiver is turned on, the car light control mode is in Default Mode.
- 3.Mode C is an emergency light working state. In this mode, the left and right turn signal lights flash synchronously and slowly as emergency lights.
- 4.This receiver identifies the neutral positions of Steering CH1 and Throttle CH2 automatically when it is powered on. It recommends to power on the receiver again after the trims of the transmitter are turned.

FRONT AXLE

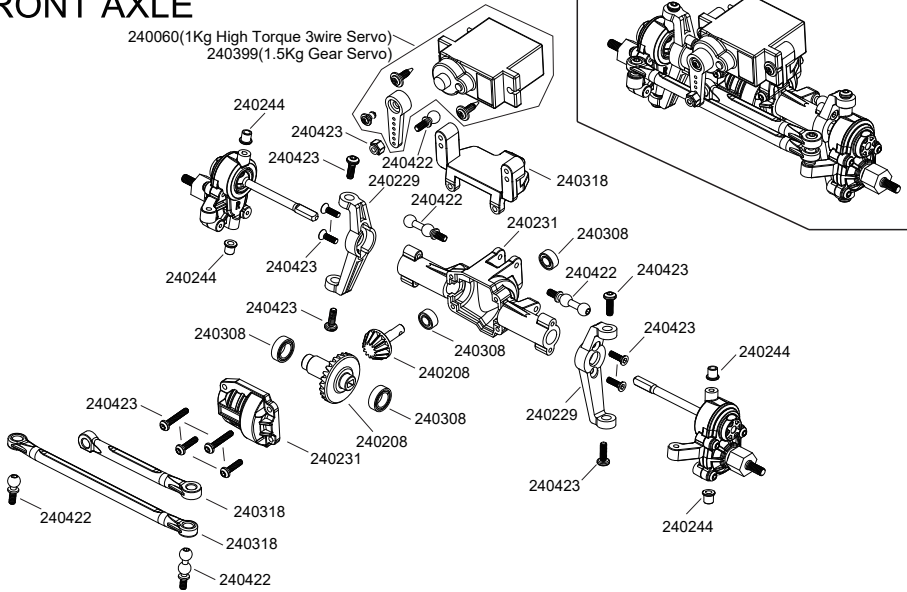

REAR AXLE

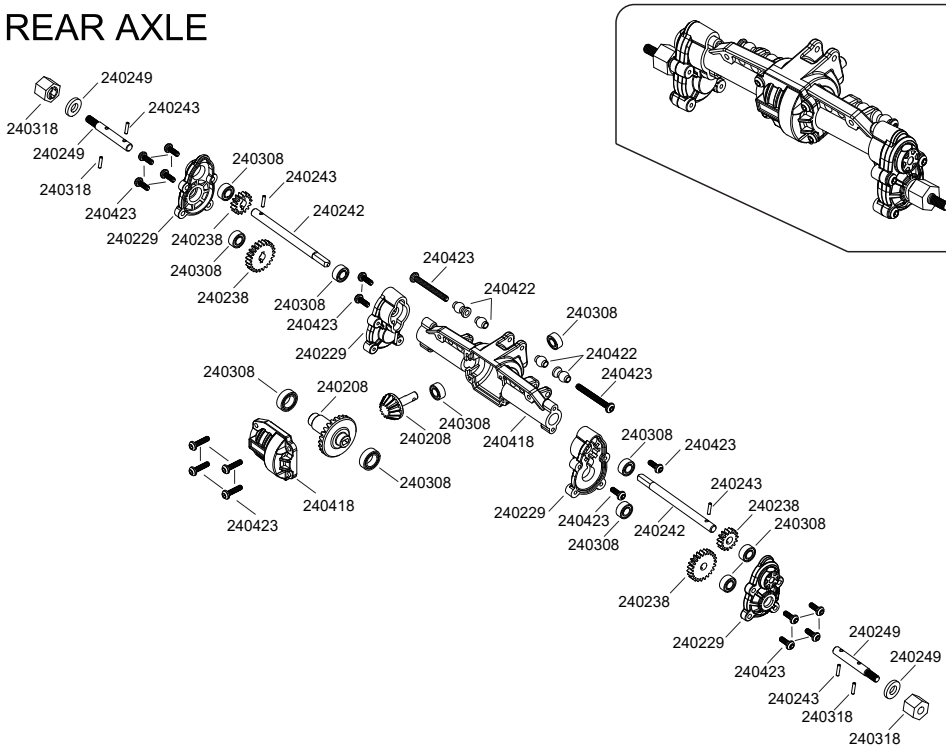

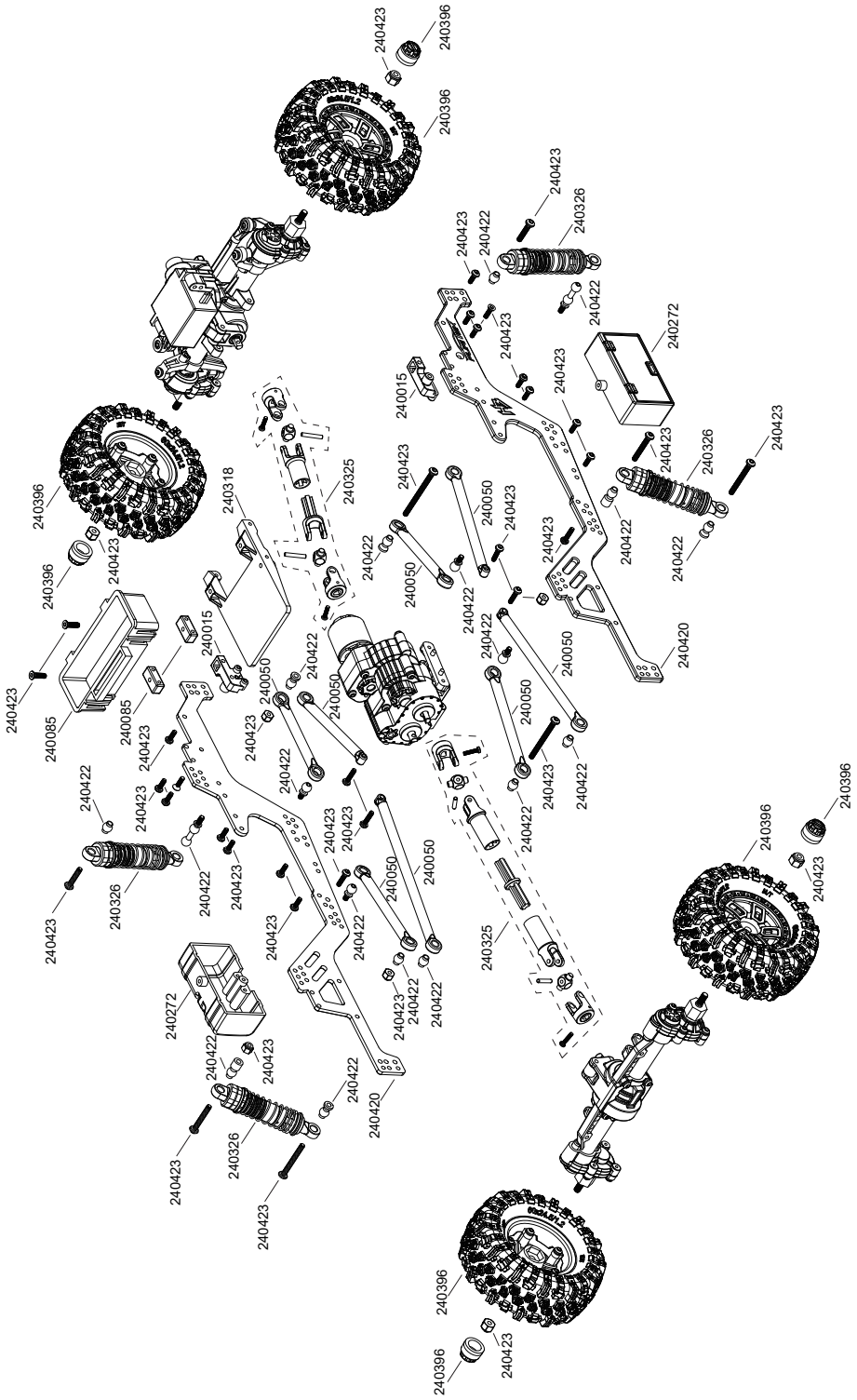

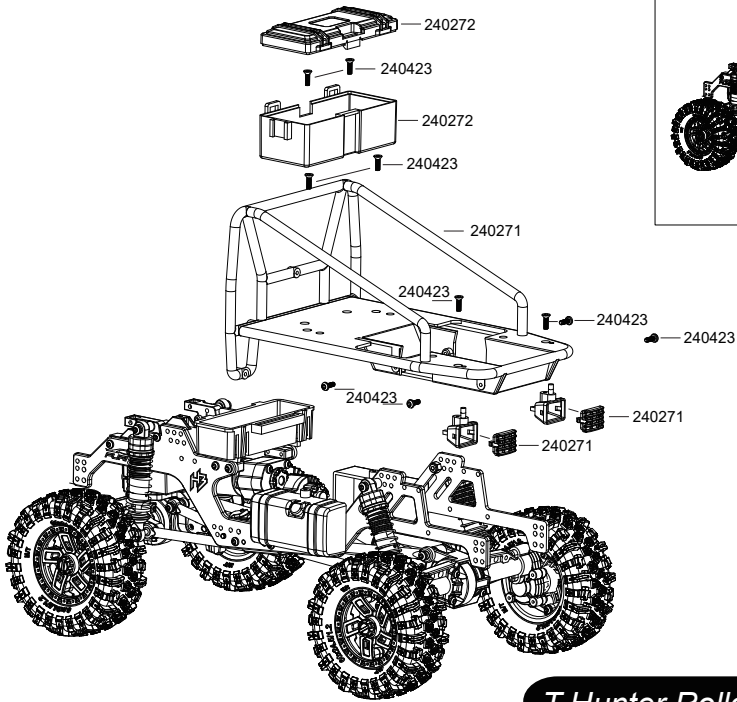

T-Hunter Rollcage Installation

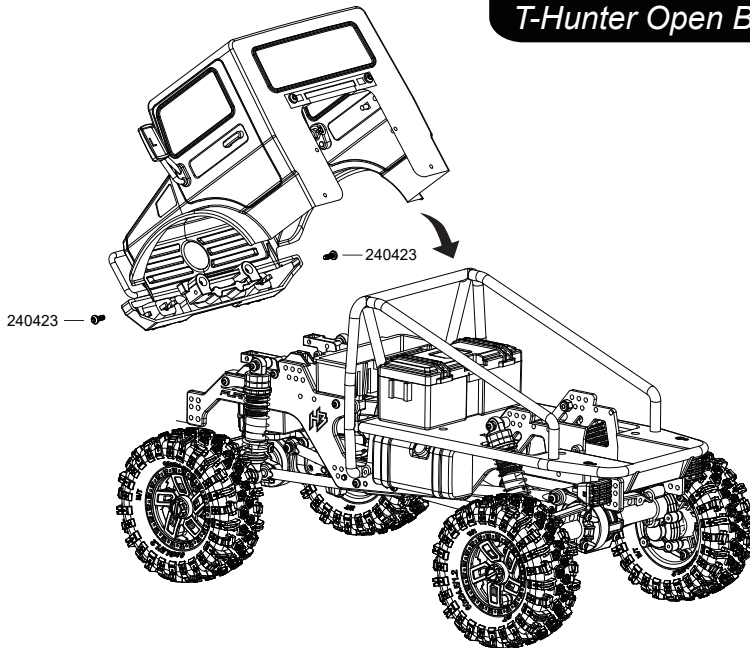

T-Hunter Open Body



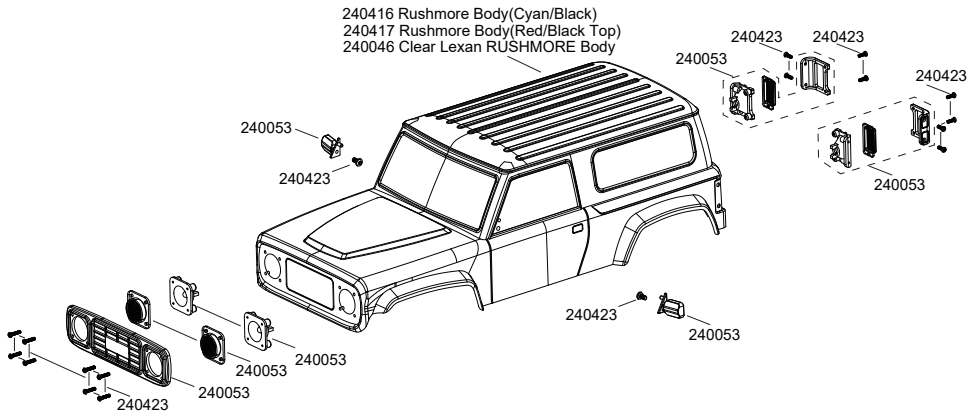



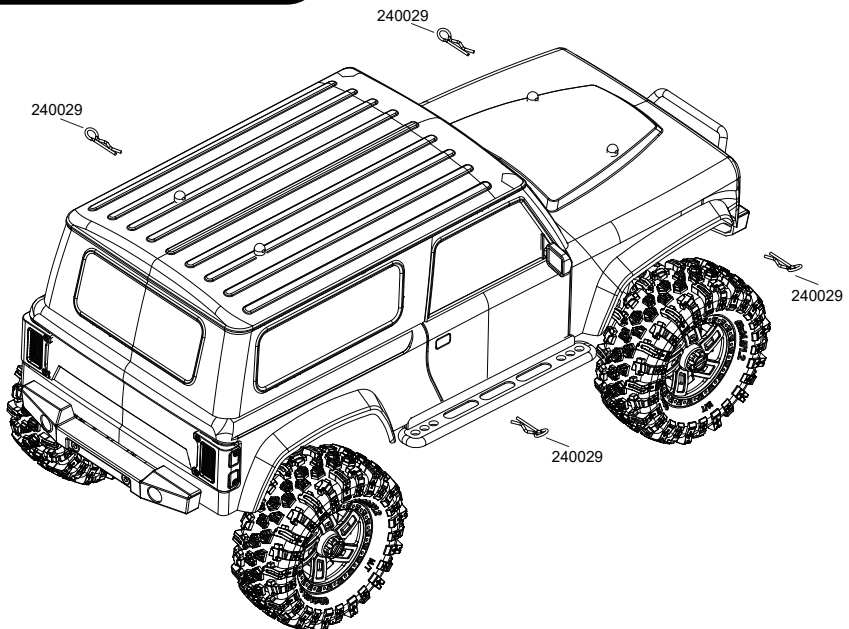



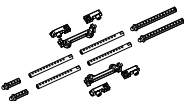

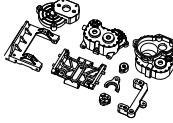
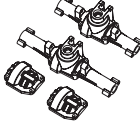
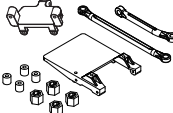
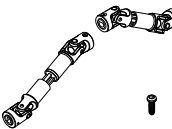
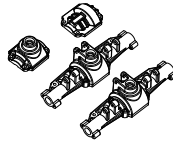

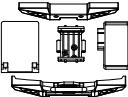
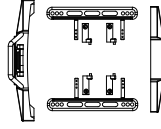
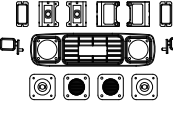
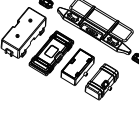
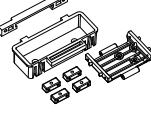
Rushmore Body Installation

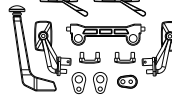
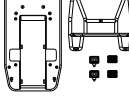



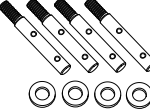
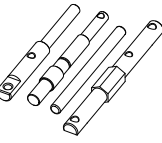
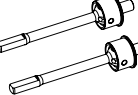
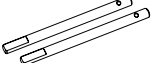

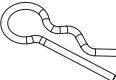

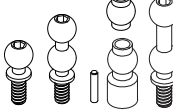



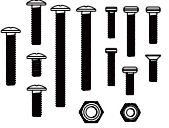

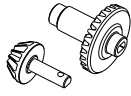
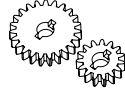
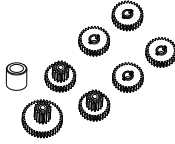
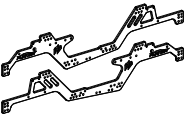

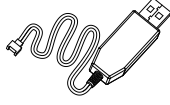
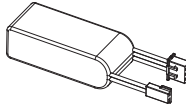
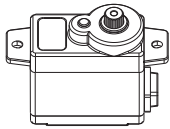
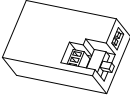
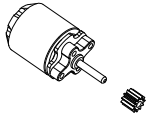
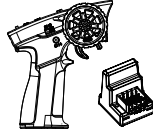
Rushmore Open Body

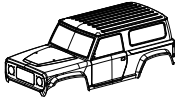

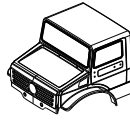

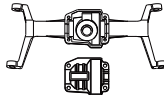
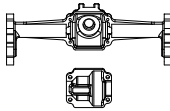
Spare parts list



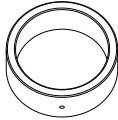
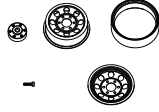
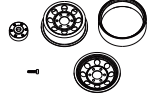
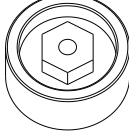

<p>Body and Bumper Post Set Part No:240015</p> 	<p>Portal Hub Part No:240229</p> 	<p>Bead Lock Wheel (1.2) Part No:240233</p> 	<p>Gear Box Part No:240300</p> 	<p>Front/Rear Axle Part No:240231</p> 
<p>Mount & Link Set Part No:240318</p> 	<p>HD Main Drive Shaft Part No:240325</p> 	<p>CR-18P Rear Portal Axle V2 Part No:240418</p> 	<p>Link Set Part No:240256</p> 	<p>CR-18 Complete Vehicle Links Set Part No:240050</p> 
<p>Bumper & Electronics Mount Set Part No:240010</p> 	<p>CR-18 Bumper & Side Step Set Part No:240047</p> 	<p>CR-18 RUSHMORE Body Light Mount Set Part No:240053</p> 	<p>T-Hunter Battery Box & Bumper Set Part No:240272</p> 	<p>Chassis Mounting Set A (Conqueror 6X6) Part No:240085</p> 
<p>T-Hunter Rollcage B Part No:240273</p> 	<p>T-Hunter Body Parts Set Part No:240282</p> 	<p>T-Hunter Rollcage A Part No:240271</p> 	<p>60mm Tire Insert Part No:240394</p> 	<p>1.2inch Mudder Tire (60mm) Comp Compound Part No:240395</p> 
<p>1.2inch Mudder Tire Set (60mm)Comp Compound Part No:240396</p> 	<p>CR18P Portal axle Shaft Part No:240249</p> 	<p>Gear Box Shaft Part No:240306</p> 	<p>Front CVD Drive Shaft Part No:240241</p> 	<p>Rear Axle Drive Shaft Part No:240242</p> 
<p>1x4.5mm Pin Part No:240243</p> 	<p>Micro Body Clip Part No:240029</p> 	<p>Spindle Hub Bushing Part No:240244</p> 	<p>Complete Bushing Set Part No:240308</p> 	<p>CR-18P 2024 Ball Stud &Pin Set Part No:240422</p> 

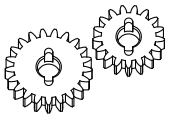
Spare parts list

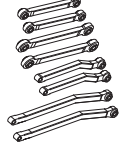
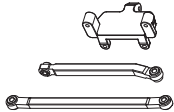
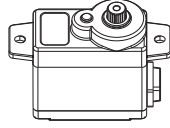
<p>CR-18P 2024 Vehicle Screw Set Part No:240423</p> 	<p>Big Bore Oil Shock Set Part No:240326</p> 	<p>Metal pinion and Ring Gear Part No:240208</p> 	<p>Metal Portal Gear Part No:240238</p> 	<p>Metal Transmission Gear Part No:240328</p> 
<p>CR-18P 2024 Aluminum LCG Chassis Part No:240420</p> 	<p>CR-18 LED light Set Part No:240064</p> 	<p>7.4V USB Charger Part No:240163</p> 	<p>7.4V 600MAH Lipo Part No:240063</p> 	<p>1KG High Torque 3wire Servo Part No:240060</p> 
<p>Furitek Lizard Brushless ESC Part No:240427</p> 	<p>15T MOD 0.4 Pinion Gear Part No:240426</p> 	<p>4Channel TX & RX Combo Part No:240332</p> 	<p>Clear Lexan RUSHMORE Body Part No:240046</p> 	<p>Rushmore Body (Cyan/Black Top) Part No:240416</p> 
<p>Rushmore Body (Cyan/Black Top) Part No:240417</p> 	<p>T-Hunter Clear Lexan Body Part No:240252</p> 	<p>T-Hunter Body (Army Green) Part No:240250</p> 	<p>T-Hunter Body (Sand) Part No:240251</p> 	<p>Finished T-Hunter Body (Army Green) Part No:240253</p> 
<p>Finished T-Hunter Body (Sand) Part No:240254</p> 	<p>Machine Aluminum Front Axle Part No:240293</p> 	<p>Machine Aluminum Rear Axle V2 Part No:240348</p> 	<p>Machine Aluminum Front Portal Hub Set V2 Part No:240391</p> 	<p>Rear Portal Hub Brass Weight V2 Part No:240392</p> 
<p>Front Portal Hub Brass Weight V2 Part No:240393</p> 	<p>Optional Brass Wheel Weight Part No:240286</p> 	<p>1.2in Steeple Bead Lock Wheel (Black) Part No:240298</p> 	<p>1.2in Steeple BeadLock Wheel (Silver) Part No:240292</p> 	<p>Optional Machine Brass Wheel Hex Part No:240287</p> 

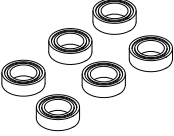
Spare parts list

<p>Machine Over Drive Portal Gear (20%) Part No:240388</p> 	<p>Optional Full Aluminum Oil Shock Part No:240339</p> 	<p>Aluminum High Clearance Link(Black) Part No:240349</p> 	<p>Optional Aluminum SOA Set Part No:240299</p> 	<p>1.5KG Metal Gear Servo Part No:240399</p> 
---	--	--	---	---

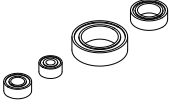
<p>8X5X2.5 Ball Bearing Part No:240368</p> 	<p>12X8X3.5 Ball Bearing Part No:240367</p> 	<p>6X3X2.5 Ball Bearing Part No:240365</p> 	<p>5X2X2.5 Ball Bearing Part No:240366</p> 	<p>Complete Ball Bearing Set Part No:240364</p> 
---	---	--	--	--

--	--	--	--	--

--	--	--	--	--

--	--	--	--	--

--	--	--	--	--

CR-1BP

Next Level of Micro Crawler performance

2024



Manufacturer: HobbyPlus RC Tech Co., Ltd
E-mail : enquiries@hobbyplus.com.cn
Website : www.hobbyplus.com.cn

WARNING : This product contains chemicals which are known to the State of California to cause cancer, birth defects, or other reproductive harm.